

Electro-Proportional Cartridge Valves



Applications

Sun electrically operated proportional pressure and flow control valves offer infinite proportional control in both pilot capacity and full flow capacity size ranges. They offer the convenience of remote controllability, varying capacities, and the T8-A control concept. Like Sun solenoid valves, these valves all use a direct acting design.

Relief Valves

- Sun proportional pilot capacity relief valves are two port valves that are available in a variety of pressure ranges.
- They are available in standard and inverse functionality (i.e. with inverse functionality, as the command increases, the pressure decreases).
- The nominal capacity is 0.25gpm (1 L/min).
- Their design allows them to be used independently, or as pilot sections in conjunction with main stage pressure control valves, achieving flows up to 200 gpm (760 L/min).

Reducing and Reducing/Relieving valves

- Reducing valves are typically used to provide a controlled lower pressure to a secondary circuit, whereas a relief valve usually controls the maximum pressure in the primary circuit.
- Sun three port proportional pressure reducing/relieving valves offer electro-proportional pressure control with relief capacity.
- These valves are also available in standard and inverse functionality. (i.e. With inverse functionality, as the command increases, the pressure decreases.)
- The nominal capacity is 5 gpm (20 L/min).
- Where larger flows are required (up to 80 gpm [320 L/min]), a pilot capacity relief can be used in conjunction with various main stage reducing and reducing/relieving valves.
- For circuits that require very fast and extremely accurate reduced pressure control, an improved dynamic response version is available.
- Even though reducing and reducing/relieving valves are normally open devices, full reverse free flow may close the main spool. The reverse flow function can be accomplished by adding a separate reverse flow check valve.

Flow Control Valves

- Sun two and three port proportional flow control valves create a metering orifice in proportion to an electrical signal.
- These valves can be specified in normally open or normally closed configurations.
- They are available in a variety of flow ranges to optimize resolution.
- The nominal maximum capacity is 10 gpm (40 L/min).

Proportional Control Amplifiers

- Sun proportional amplifiers are specifically designed to control Sun electro-proportional valves.
- They are available in both DIN plug mount and embedded styles.
- The embedded style is rated as IP-69K with the Deutsch connector.
- Both styles are easily configured with the optional Sun hand-held programmer.
- For complete information on Sun amplifiers, refer to Sun tech tips on proportional amplifiers.

Design Concepts and Features

Common Features shared by all Sun Electro-proportional Solenoid Valves

- They are direct acting and do not require either a minimum pilot pressure or pilot flow for valve actuation.
- Their operation is based on a force balance design principle. *(The solenoid force can proportionally counteract the hydraulic force acting upon it.)*
- All proportional solenoid tubes are fatigue rated for 5000 psi (350 bar) service, allowing these valves to be rated at 5000 psi (350 bar) on all ports.
- The proportional solenoid is a low friction, push type, wetted armature design.
- The solenoid force characteristics are relatively constant throughout its stroke.
- Advertised valve performance is based on using a dither (PWM) frequency input.
 - ◇ The recommended dither (PWM) frequency is 140Hz. *(The default value that is used to achieve advertised performance specifications for all valves.)*
 - ◇ Valve hysteresis, with dither (PWM), is normally less than 4%.
 - ◇ A variable analog DC power signal can also be used to power the valves. *(However, hysteresis values can be greater than 7%. This method of power delivery will generate much higher electrical circuit temperatures due to high inefficiency.)*
 - ◇ Too low a dither (PWM) frequency can create a small pressure ripple in pressure control elements. *(This problem can be easily diagnosed by changing the dither frequency and monitoring the results.)*

Please note: All Sun electro-proportional solenoid valves are designed for use with mineral based hydraulic fluid. *(The use of other fluids may cause the valve not to function as intended.)*

Electro-proportional Relief Valves

Two Port pilot capacity electro-proportional relief valves – RBAP and RBAN

The RBAP standard relief valve and the RBAN inverse relief valve are usually used to pilot larger pressure control valves. The RBAP relief cartridge is normally open and increasing the current to the coil increases the pressure at port 1. The RBAN inverse relief cartridge is normally closed at a preset, customer specified, factory setting and increasing the current to the coil reduces the pressure at port 1. Performance parameters include:

- Utilizes the T-8A cavity.
- Nominal capacity is 0.25 GPM (1 L/min). *(Used in conjunction with a main stage relief or reducing valve, flow rates up to 200gpm [760L/min] can be obtained. See Figure 1.)*
- Cavity Adapter, model no. XFAA-8X*, T-8A to T-10A, can be used to replace an RBAC with an RBAP in existing applications.
- The “L” control on the RBAP allows a minimum or offset relief pressure to be set with no signal present. *(However, the offset pressure will effectively increase the maximum setting of the valve.)*
- The RBAN does not offer a manual override option. *(After incorporating the customer specified setting, the assembly is factory sealed.)*
- In the de-energized state, the inverse relief will be at its preset maximum relief setting.
- Any backpressure downstream of port 2 will increase setting at a 1:1 ratio.
- Damped vs. undamped armature:
 - ◊ A desirable feature that improves the pressure trace is the damped armature that is available on all versions with the exception of the “M” override option (the original offering).
 - ◊ The damped armature results in a reduction of pressure amplitude changes with a minimal effect on response. Figure 2 shows a comparison between a damped and undamped valve, flowing about .25 gpm (0,95 L/min).

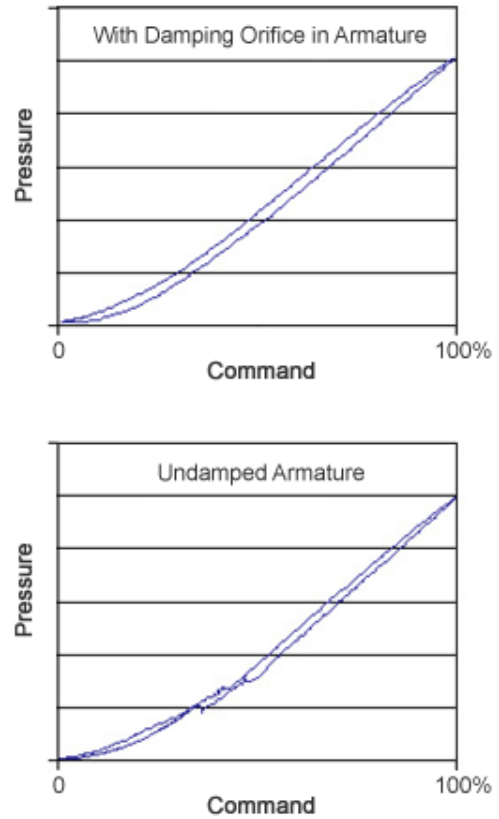

Figure 2.
Pressure vs. command curves for an RBAP with and without a damping orifice in the armature.

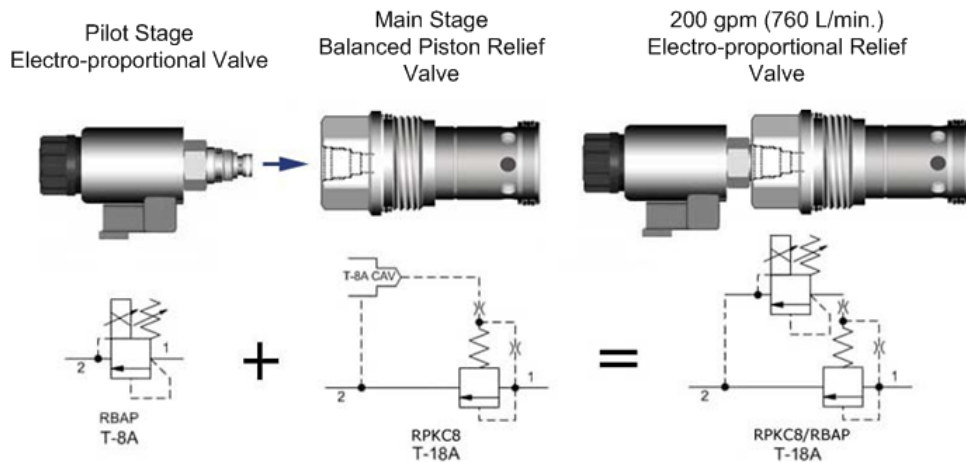

Figure 1.

Using the T-8A cavity concept, an electro-proportional pilot capacity relief valve can control a main stage relief valve.

Electro-proportional reducing/relieving valves

Three port electro-proportional reducing/relieving valves – PRDP and PRDN

The PRDP, standard reducing/relieving valve, and the PRDN, inverse function reducing/relieving valve, are direct acting electro-proportional cartridges that reduce a high inlet pressure at port 2 to a reduced pressure at port 1. In the relieving mode, relief flow is diverted to port 3. The PRDP reducing/relieving cartridge is biased to the relieving mode, with port 1 open to port 3. Increasing the current to the coil, proportionally increases the pressure at port 1. The PRDN inverse reducing/relieving cartridge is normally closed at a preset, customer specified, factory setting and increasing current to the coil reduces the pressure at port 1. Performance parameters include:

- Nominal flow rating is 5 GPM (20 L/min), and the maximum inlet pressure should not exceed 5000 psi (350 Bar).
- The available pressure ranges are: “B” 100-1200 psi (7-80 bar), “D” 50-500 psi (3.5-35 bar), and “E” 25-250 psi,(1,7 -18 bar).
- The PRDP has three manual override options;
 - ◊ “M” (standard) momentary push type *(With the “M” override, there is no way to limit the maximum reduced pressure setting. The maximum pressure will be equal to the inlet pressure at port 2.)*
 - ◊ “L” control, which allows a minimum or offset reduced pressure to be set with no signal present. *(However, the offset pressure will effectively increase the maximum setting of the valve. See Figure 3.)*
 - ◊ “E” twist style, momentary operation. A 90° rotation will result in manually increasing the reduced pressure up to a maximum of 50% of the selected pressure range.

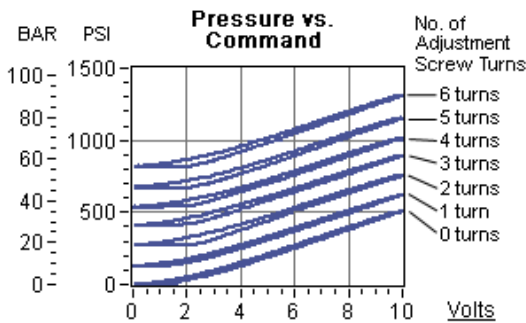

Figure 3.

Biased pressure ranges for a PRDP-LDN based on number of override turns.

- The PRDN does not offer a manual override option. *(After incorporating the customer specified setting, the cartridge is sealed at the factory.)*
- For best performance, a full capacity drain line is required for port 3. Any backpressure will directly add to the setting at a 1:1 ratio.
- The transition from reducing to relieving is closed, resulting in very low leakage (2.5 in³/min [41 cc/min]). However, this transition becomes a step increase in pressure between the

reducing and relieving modes. This step is independent of the actual pressure setting, and is equal to about 5% of the maximum pressure of the adjustment range. *(This characteristic may make these valves unsuitable in counterbalancing applications. Consider PRDL or PRDM version if this transitional step could be an application problem.)*

Three port electro-proportional reducing/relieving valves with open transition – PRDL and PRDM

The PRDL, standard reducing/relieving valve, and the PRDM, inverse function reducing/relieving valve, have slightly underlapped spools that result in an open transition between the reducing and relieving modes. These valves have performance parameters similar to PRDP and PRDN valves with the following exceptions:

- The underlapped spool design results in a valve with improved dynamic response.
- The open transition does result in a higher leakage flow of 0.1 gpm (0,4 L/min). *(This leakage flow should only be a factor in a dead headed flow condition.)*
- The improved dynamic response afforded by the open transition allows for precise down stream pressure regulation, especially when external forces tend to cause this pressure to rise. (See Figure 4.)

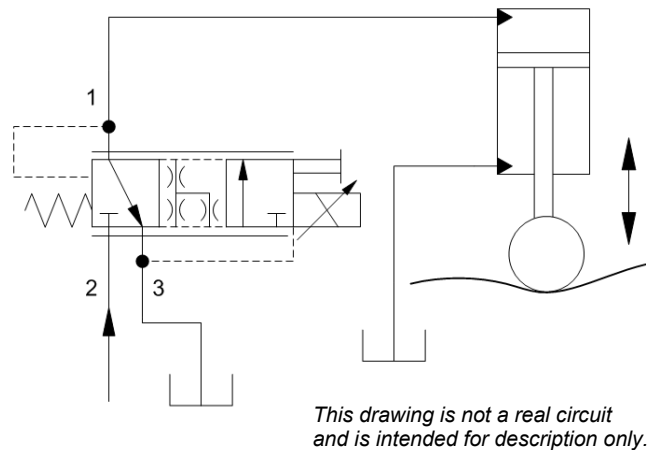

Figure 4.

A PRDL reducing/relieving valve can be used for precise force (pressure) control in a floating cylinder application.

Three port pilot operated reducing/relieving valves with integral T-8A cavities– PP*B-8 and PPDL-8

Where higher electro-proportional reducing/relieving flows are required, PP*B-8 (available in Series 1 through Series 4 frame sizes) and PPDL-8 (series 1 only) pilot operated valves make excellent choices. Some important performance parameters to consider include:

- These pilot operated versions achieve an almost stepless transition between the reducing and relieving mode.
- The PP*B-8 valves exhibit a control pilot flow of 7-10 in³/min (0,11-0,16 L/min).



- The PPDL-8, improved dynamic response valve, incorporates a slightly underlapped spool as well as a smaller pilot orifice. (Control pilot flow increases to 25-30 in³/min [0,16-0,50 L/min]).
- The choice of an RBAP-X, RBAP-L, or an RBAN pilot valve, with the damping orifice, is recommended, especially with the improved dynamic response PPDL-8 version.

Four port reducing/relieving electro-proportional valves – PSDP and PSDL

The PSDP low leakage reducing/relieving valve and the PSDL improved dynamic response reducing/relieving valve have a fourth external drain port. These valves have performance parameters similar to PRDP and PRDL valves with the following exceptions:

- The port 4 external drain eliminates the effects of pressure variations at port 3 on the valve’s setting.
- Pressure at port 4 will hydraulically bias, or boost, the valve setting. (This feature allows the maximum reduced pressure to be increased if the available adjustment range(s) is acceptable for the application.) (See Figure 5.)

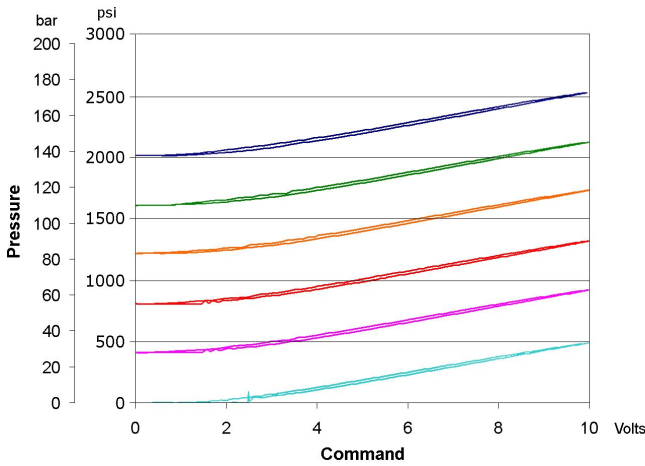

Figure 5.
Remote Pressure Settings ranging from 0 to 140 bar Pressure vs. command curves with 400 psi (28 bar) steps applied to port 4 of a PSDL-XBN to boost the maximum (and minimum) pressure.

Four port pilot operated reducing/relieving valves with integral T-8A cavities– PV*A-8 and PVHL-8

Where higher electro-proportional reducing/relieving flows are required in a four port configuration, PV*A-8 (available in Series 1 through Series 4 frame sizes) and PVHL-8 (series 1 only) pilot operated valves are available. These valves have performance parameters similar to PP*B-8 and PPDL-8 valves with the following exceptions:

- The port 4 external drain eliminates the effects of pressure variations at port 3 on the valve’s setting.
- Any pressure at port 4 will be additive to the valve’s pressure setting. (With the pressure adjustment ranges available with the RBAP-X, RBAP-L, or RBAN pilot valves, adding bias pressure at port 4 is not required to raise the maximum reduced pressure.)

Electro-proportional flow control valves

Two port electro-proportional flow control valves – FPCC and FPCH

The FPCC, normally closed, and FPCH, normally open, direct acting electro-proportional flow control valves are available in four flow ranges for the FPCC, and three flow ranges for the FPCH. The “A”, “B”, and “C” ranges are the same for both versions (“A” = .1-1.5 gpm [0,4—6L/min], “B” = .15-3.5 gpm [0,6-14 L/min] and “C” = .25-7 gpm [1-28 L/min]). The FPCC also offers a “D” range; .25-10 gpm (1-40 L/min). Performance parameters include:

- These valves exhibit some degree of self compensation flowing in the 1 to 2 direction.
- For the highest degree of flow accuracy, it is recommended that a compensator be added. (A compensator is especially necessary when flowing in the 2-1 direction.)
- Valve flow ratings are based on using a 200 psi (14 bar) compensator. (See Figure 6.) (The curves in Figure 7 show flow capacities using other compensator differentials.)
- Maximum valve leakage is 6 in3/min @ 3000 psi (100 cc/min @ 210 bar) (The FPCC at zero command and the FPCH at 100% command).
- All series 1 solenoid actuator manual override options are available.
- When synchronizing two cylinders in a higher flow application, two FPCC (or FPCH) flow controls can be used in conjunction with a flow divider in lieu of a larger, more expensive proportional directional valve. (See Figure 8.)

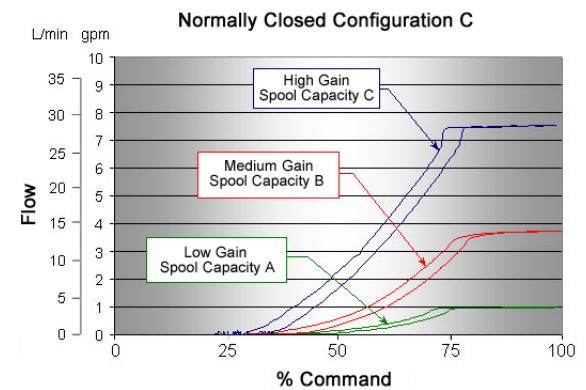
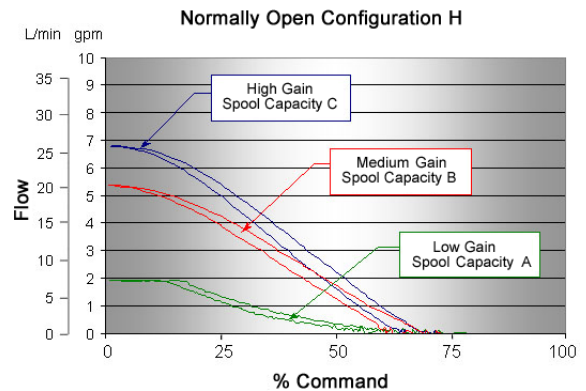

Figure 6.
Both the FPCH, normally open, and FPCC, normally closed versions are rated based upon their capacity when used in conjunction with a 200 psi (14 bar) restrictive compensator.



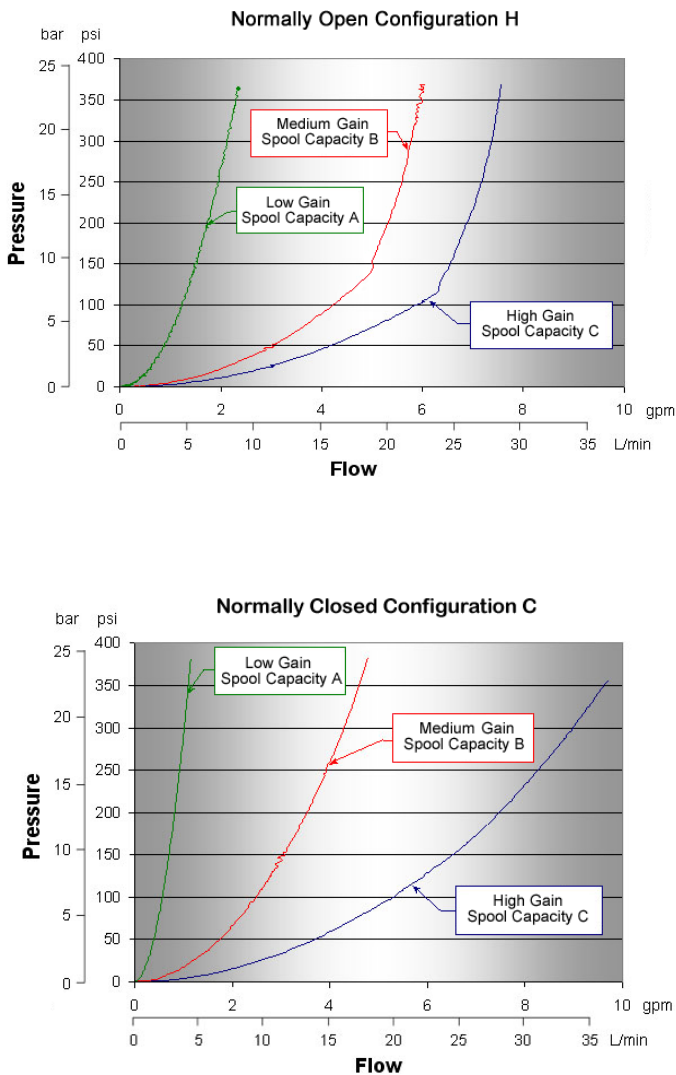

Figure 7. For various compensator differentials, the approximate FPCH and FPCC flow capacities may be estimated from the above curves.

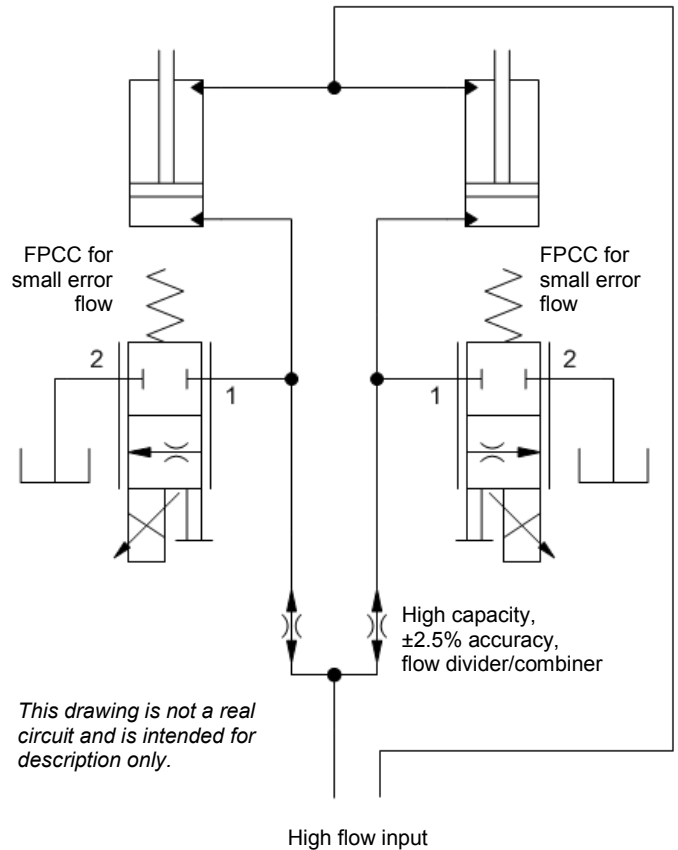

Figure 8. In this cylinder synchronizing application, a high capacity, high accuracy, flow divider/combiner plus two FPCC flow controls are being used. The flow range of the FPCC is selected based on the maximum flow divider error flow. Position feedback is still required, but the need for a costly high flow proportional solenoid valve or servo valve is avoided.

Three port electro-proportional flow control valves – FMDA and FMDB

Sun FMDA and FMDB, three port, 3-way, electro-proportional flow controls, are direct acting, meter-in, Series 1 valves. In the de-energized condition, port 1 is blocked and port 2 is connected to port 3. The FMDA valves are available in four flow ranges, and FMDB valves are available in three flow ranges. The “A”, “B”, and “C” ranges are common to both versions (“A” = .1-1.6 gpm [0,4–6,1 L/min], “B” = .1-4 gpm [0,4-15 L/min] and “C” = .1-6 gpm [0,4-23 L/min]). The FMDA also offers a “D” range, .1-9 gpm, (1,4-34 L/min). Performance parameters include:

- All flow ratings are based on a flow direction from 1 to 2.
- These valves have good self compensation flowing in the 1 to 2 direction.
- Valve flow ratings are based on using a 200 psi (14 bar) compensator.
- The transition between positions is closed.

- Maximum valve leakage is 2 in³/min @ 1000 psi (30 cc/min @ 70 bar).
- All series 1 solenoid actuator manual override options are available.
- Flow from 2 to 3 is **not** proportional.
- FMDA cartridges offer very good control resolution, but return flow capacity is limited to 1.5 gpm (6 L/min). (See flow curves in Figure 9.)
- FMDB cartridges offer lower control resolution, but full 2-3 return flow capacity is maintained. (See flow curves in Figure 10.)
- Two FMDB series valves can be used to create a 4-way, 3-position function where the return passage for flow is through the valve. (See Figure 11.)
- Two FMDA series valves can be used as the meter-in elements in a 4-way 3-position meter-in/meter-out cushion lock circuit where the return flow to tank is via a separate passage. (See Figure 12.)
- Two different proportional flow ranges can be chosen to match various cylinder ratios, with either the 4-way function or the cushion lock circuit shown in figures 11 and 12. (*This approach negates the need for special ratio spools.*)

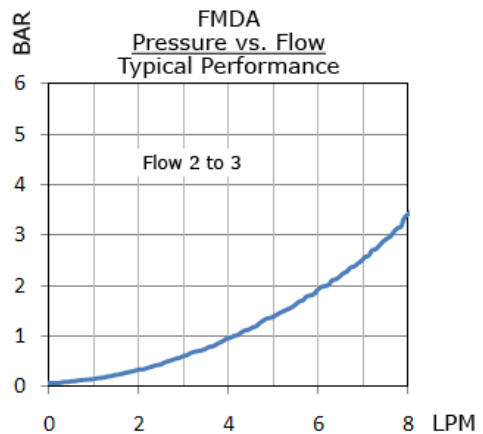
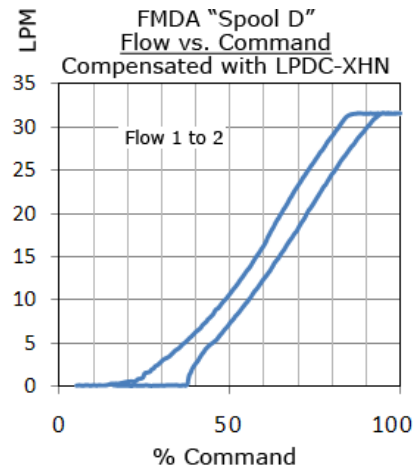
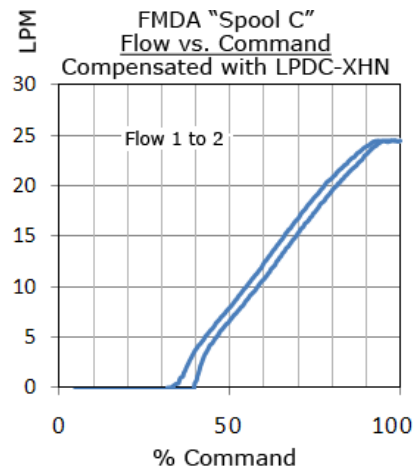
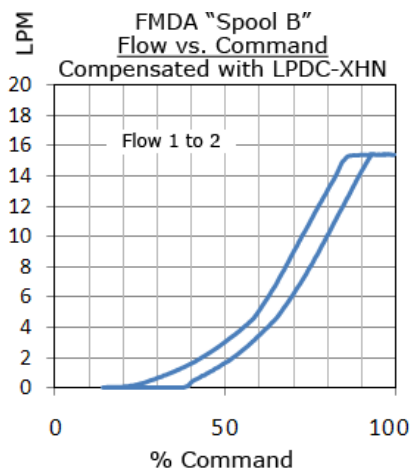
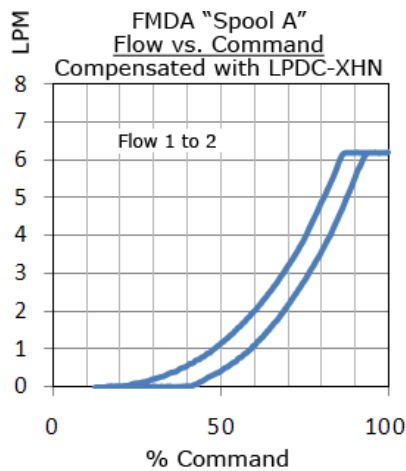

Figure 9.
FMDA flow curves using a 200 psi (14 bar) restrictive compensator.

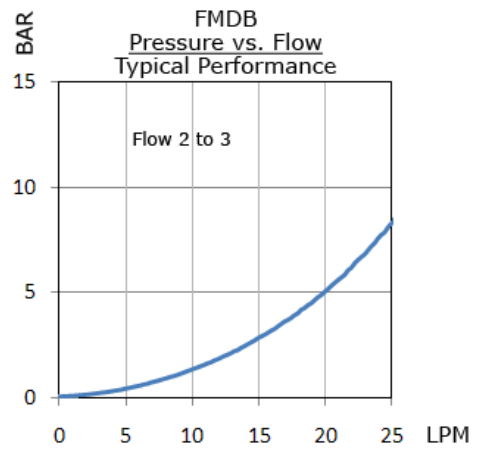
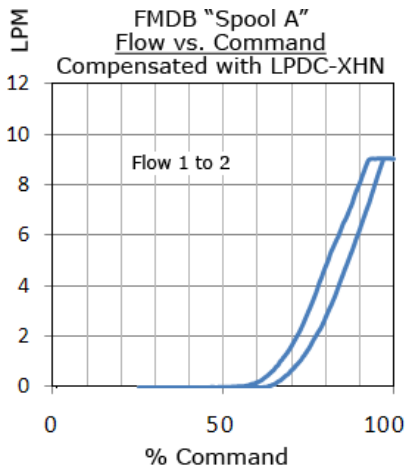
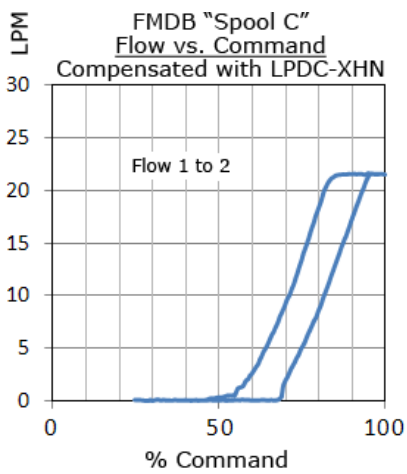
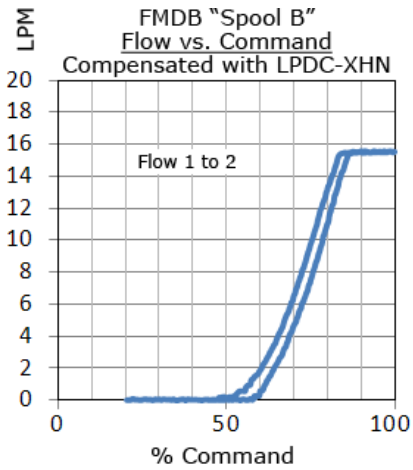

Figure 10.
FMDB flow curves using a 200 psi (14 bar) restrictive compensator.



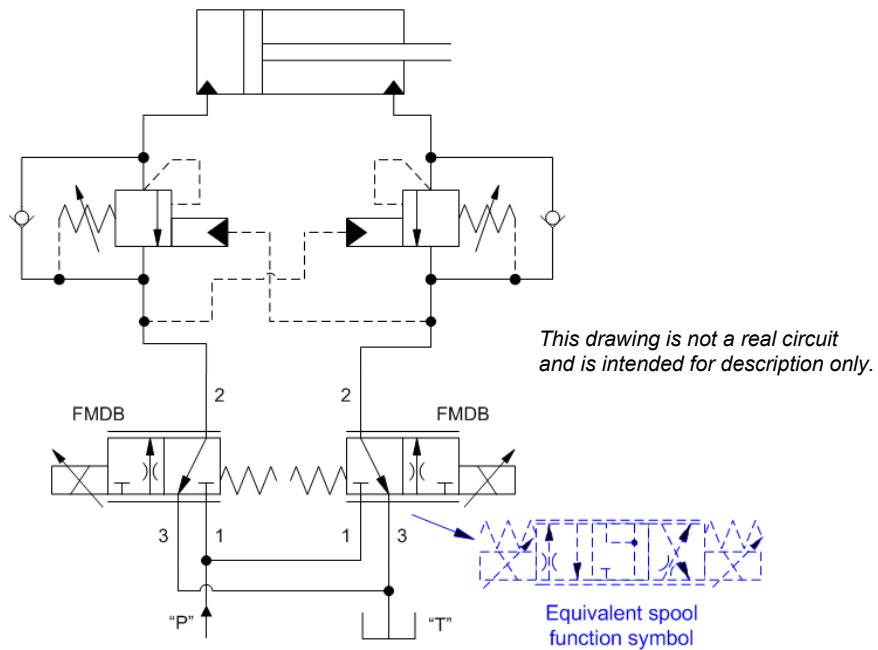

Figure 11.

Two FMDB 3-way proportional valves can replace a 3-position, 4-way proportional spool valve. (The two counterbalance valves are connected in series with the FMDB work ports.)

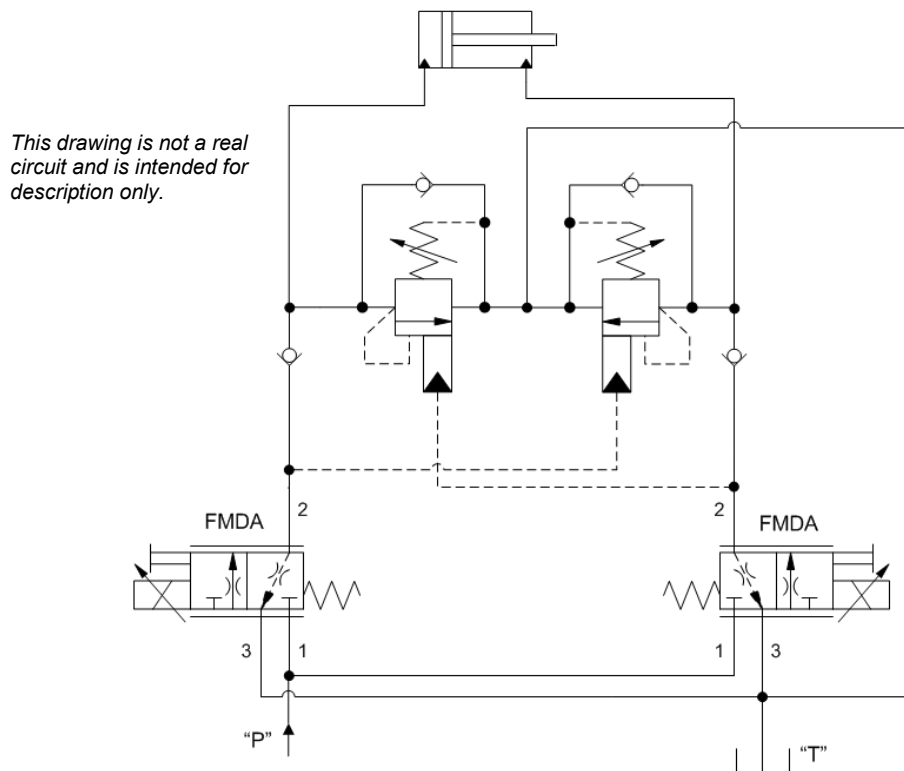

Figure 12.

Here, two FMDA proportional 3-way valves are used as meter-in elements in a cushion lock circuit. (The flow path from the two counterbalance valves is from the FMDA work ports to tank.)

Electro-Proportional Cartridge Valves Overview

Function	Description	Nominal Capacity	Model	Cavity	Symbol
Relief	2-Port, Pilot Relief	.25 gpm (1 L/min.)	RBAP	T-8A	
Relief	2-Port, Relief - Inverse Function	.25 gpm (1 L/min.)	RBAN	T-8A	
Relief	2-Port, Balanced Piston, Relief	25 gpm (95 L/min.) 50 gpm (200 L/min.) 100 gpm (380 L/min.) 200 gpm (760 L/min.)	RPEC8 RPGC8 RPIC8 RPKC8	T-10A T-3A T-16A T-18A	
Relief	2-Port, Balanced Poppet, Relief	50 gpm (200 L/min.) 100 gpm (380 L/min.) 200 gpm (760 L/min.)	RPGS8 RPIS8 RPKS8	T-3A T-16A T-18A	
Relief	3-Port, Balanced Piston, Relief	15 gpm (60 L/min.) 30 gpm (120 L/min.) 60 gpm (240 L/min.) 120 gpm (480 L/min.)	RSDC8 RSFC8 RSHC8 RSJC8	T-11A T-2A T-17A T-19A	

Electro-Proportional Cartridge Valves Overview (continued)

Function	Description	Nominal Capacity	Model	Cavity	Symbol
Relief	3-Port, Balanced Poppet, Relief	30 gpm (120 L/min.) 60 gpm (240 L/min.) 120 gpm (480 L/min.)	RSFS8 RSHS8 RSJS8	T-2A T-17A T-19A	
Relief	4-Port, Balanced Piston, Relief	15 gpm (60 L/min.) 30 gpm (120 L/min.) 60 gpm (240 L/min.) 120 gpm (480 L/min.)	RVCD8 RVED8 RVGD8 RVID8	T-21A T-22A T-23A T-24A	
Relief	3 Port	10 gpm (40 L/min.) 20 gpm (80 L/min.) 40 gpm (160 L/min.) 80 gpm (320 L/min.)	PBDB8 PFBF8 PBHB8 PJB8	T-11A T-2A T-17A T-19A	
Reducing/Relieving	3-Port, Direct Acting, Low Leakage	5 gpm (20 L/min.)	PRDP	T-11A	
Reducing/Relieving	3-Port, Direct Acting, Low Leakage- Inverse Function	5 gpm (20 L/min.)	PRDN	T-11A	

Electro-Proportional Cartridge Valves Overview (continued)

Function	Description	Nominal Capacity	Model	Cavity	Symbol
Reducing/Relieving	3-Port, Direct Acting, Improved Dynamic Response	5 gpm (20 L/min.)	PRDL	T-11A	
Reducing/Relieving	3-Port, Direct Acting, Improved Dynamic Response- Inverse Function	5 gpm (20 L/min.)	PRDM	T-11A	
Reducing/Relieving	3-Port, Integral T-8A Pilot Cavity	10 gpm (40 L/min.) 20 gpm (80 L/min.) 40 gpm (160 L/min.) 80 gpm (320 L/min.)	PPDB8 PPFB8 PPHB8 PPJB8	T-11A T-2A T-17A T-19A	
Reducing/Relieving	3-Port, Integral T-8A Pilot Cavity, Improved Dynamic Response	10 gpm (40 L/min.)	PPDL8	T-11A	

Electro-Proportional Cartridge Valves Overview (continued)

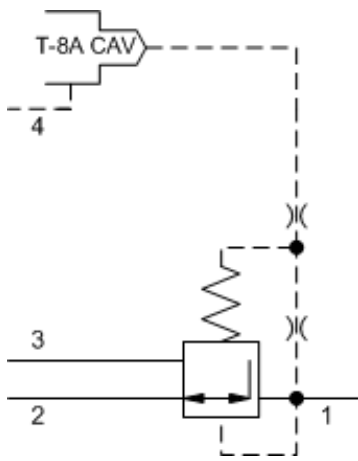
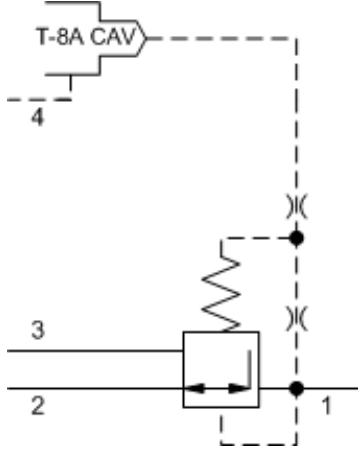
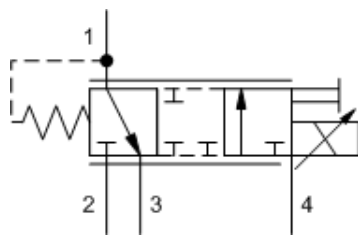
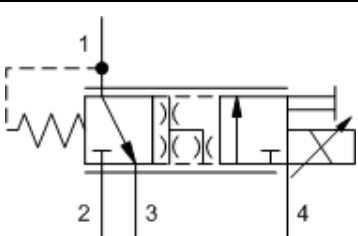
Function	Description	Nominal Capacity	Model	Cavity	Symbol
Reducing/Relieving	3-Port, Integral T-8A Pilot Cavity, Improved Dynamic Response	10 gpm (40 L/min.) 20 gpm (80 L/min.) 40 gpm (160 L/min.) 80 gpm (320 L/min.)	PVDA8 PVFA8 PVHA8 PVJA8	T-21A T-22A T-23A T-24A	
Reducing/Relieving	3-Port, Integral T-8A Pilot Cavity, Improved Dynamic Response	40 gpm (160 L/min.)	PVHL8	T-23A	
Reducing/Relieving	3-Port, Integral T-8A Pilot Cavity, Improved Dynamic Response	5 gpm (20 L/min.)	PSDP	T-21A	
Reducing/Relieving	4-Port, Direct Acting, Improved Dynamic Response, Externally Drained	5 gpm (20 L/min.)	PSDL	T-21A	

Electro-Proportional Cartridge Valves Overview (continued)

Function	Description	Nominal Capacity	Model	Cavity	Symbol
Flow Control	3-port, Meter in Throttle	9 gpm (34 L/min.) 6 gpm (23 L/min.)	FMDA FMDB	T-11A T-11A	
Flow Control	Normally Closed Throttle	10 gpm (40 L/min.)	FPCC	T-13A	
Flow Control	Normally Open Throttle	7 gpm (28 L/min.)	FPCH	T-13A	