

The Embedded Electronics Amplifier is a compact, low profile coil/controller combination for use with proportional solenoid valves. The Amplifier provides current to the coil in proportion to an input signal. Bright LED indicators on the unit provide an overview of the operating status. Setup is accomplished using Sun's PC-based Amplifier Set Up Software or Hand Held Programmer (HHP). There is no cover to remove and no tiny pots to set. Once configured, the settings are stored in permanent memory within the unit.

- Easily configured using Sun's hand held interface or PC-based software
- LED indication of Status and Output Current
- Standard DIN 43650-Form A Connector
- Selectable dither frequency up to 300 Hz
- Adjustable current limited output with short circuit protection
- 5 Volt reference for potentiometer/joystick controls is optional
- Multiple modes for analog or 2-speed control
- Programmable enable input optional
- All input and output limits are independently adjustable
- Adjustable ramp up and ramp down times, independently set
- Microprocessor controlled for consistent, reliable performance
- CE approved – Emission test: EN55011: 1998/A1: 1999, Immunity test: EN61326: 1997/A1: 1998/A2: 2001



**Operating Specifications:**

Supply Voltage	<b>790-2*24A:</b> 21.6-28 V, 24V Recommended <b>790-2*12A:</b> 10.8-28 V, 12V Recommended
Supply Current	I <sub>SOL</sub> + 20 mA
Output Current	<b>790-2*24A:</b> 24 V Coil, 600 mA max. <b>790-2*12A:</b> 12 V Coil, 1200 mA max.
Reference Voltage	+5V @ 1 mA * <i>Optional</i>
Dither Settings	80-300 Hz, 20 Hz increments
Analog Input Range	0 – 20 Ma (source type)
Analog Input Impedance	250 Ω
Operating Temperature Range	-4° F to 158° F (-20° C to 70° C)
Enclosure	Glass filled nylon with Lexan light pipes, polyurethane potting compound
Ramp Up Time	0 – 120.0 s, 0.5 s increments
Ramp Down Time	0 – 120.0 s, 0.5 s increments

**Physical Description**

The Embedded Amplifier is shown at the right. There are two indicator lamps labeled STATUS and ACTIVE. The STATUS lamp will light green whenever power is applied to the unit and is within the specified voltage range. The STATUS light will flash red when a fault has occurred. The type of fault is indicated by the number of successive flashes. It will continue to flash until the command signal has been removed to clear the fault. The amber lamp labeled ACTIVE provides an indication of the current being supplied to the solenoid outputs.

Communication with the Embedded Amplifier takes place through two infrared communication windows. These windows allow for configuration and monitoring of the operating parameters, and therefore must remain free from any obstruction such as paint or other material. The infrared adapter cable clips onto the Embedded Amplifier in the notches located between the coil housing and amplifier section.

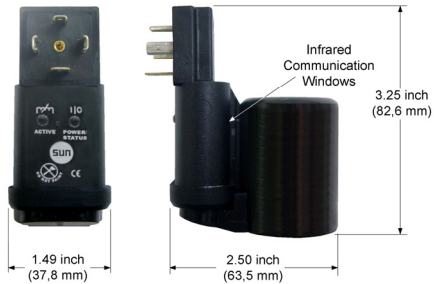

**User Interface**

The Embedded Amplifier has a number of internal settings which allow each unit to be configured for the application in which it is used. These settings are accomplished using Sun's PC-based Amplifier Set Up Software or Hand Held Programmer (Sun p/n 991-700). Infrared Cables are available to communicate between the Amplifier and the PC or the HHP (USB cable p/n: 991-704 and Serial cable p/n: 991-702).

**Parameter List**

The following table outlines the parameter list for the Amplifier. Along with the name of the parameter and its type, the table lists the limits and units for each item.

Parameter	Type	Limits	Default Settings	Units
790-2***A	FIXED			Version #
MODE	VARIABLE	See Mode Description	1	Mode #
MINIMUM INPUT	VARIABLE	0 to 20	4	mA
MAXIMUM INPUT	VARIABLE	0 to 20	20	mA
MINIMUM OUTPUT	VARIABLE	0 to 600 or 1200	5	mA
MAXIMUM OUTPUT	VARIABLE	0 to 600 or 1200	590 or 1150	mA
DITHER FREQ.	VARIABLE	Off, 80 to 300	140	Hz.
RAMP UP TIME	VARIABLE	0.0 to 120.0	0	Seconds
RAMP DOWN TIME	VARIABLE	0.0 to 120.0	0	Seconds
COMMAND SIGNAL	MONITOR			Volts
OUTPUT CURRENT	MONITOR			mA
SUPPLY VOLTAGE	MONITOR			Volts
FAULT STATUS	MONITOR			Fault

**790-2\*\*\*A** – This is the title parameter. The model number of the unit and the firmware version are displayed. The title parameter is fixed.

**MODE** – There are six modes of operation for the Amplifier. These modes are as follows:

- 1) Output proportional to input with Enable not used.
- 2) Output inversely proportional to input with Enable not used.
- 3) Output proportional to input with Enable. \*
- 4) Output inversely proportional to input with Enable. \*
- 5) Two speed where Enable provides output at the level set in Minimum Output and Command provides output at the level set in Maximum Output. \*
- 6) Two speed where Enable provides output at the level set in Maximum Output and Command provides output at the level set in Minimum Output. \*

\* **Note:** Available modes are dependent upon the fourth pin option selected.

The Ramp Up and Ramp Down times apply to all modes. The Mode parameter is variable.

**MINIMUM INPUT** - The Minimum Input parameter is used to establish the minimum analog command which results in activation of the output. The value shown in square brackets is the actual analog value except while in Inverse Modes 2 and 4. In the Inverse Mode, the value shown in the square brackets is the inverse of the actual value, e.g. 20 mA command is displayed as 0 mA. The Minimum Input parameter is a combination variable/monitor type.

**MAXIMUM INPUT** - The Maximum Input parameter is used to establish the maximum analog command for scaling of the output. The output will hold its maximum value for any input equal to or greater than this value. The value shown in square brackets is the actual analog value except while in Inverse Modes 2 and 4. In the Inverse Mode, the value shown in the square brackets is the inverse of the actual value, e.g. 20 mA command is displayed as 0 mA. The Maximum Input parameter is a combination variable/monitor type.

**MINIMUM OUTPUT** - The Minimum Output parameter represents the minimum current of the output. This is often referred to as the dead band. The value displayed represents the current in milliamps (Amps for 2\*12A). The Minimum Output parameter is variable.

**MAXIMUM OUTPUT** - The Maximum Output parameter represents the maximum current of the output. This is often referred to as the gain. The value displayed represents the current in milliamps (Amps for 2\*12A). The Maximum Output parameter is variable.

**DITHER FREQ.** - The Dither Frequency parameter has 13 options for dither control. The choices are Off, 80 to 300 Hz in 20 Hz increments. Dither control provides low frequency modulation which is required in many proportional valve applications. The Dither Frequency parameter is variable.

**RAMP UP/DOWN TIME** - Ramp Up Time and Ramp Down Time are used to limit the rate of change of the input command signal, and therefore the ramp time of the output. The amount of time required to ramp through the full input range is set by these parameters. When the input command is increasing, the Ramp Up Time is used. When the input command is decreasing, the Ramp Down Time is used. The Ramp Up/Ramp Down Time parameters are variable.

**COMMAND SIGNAL** - The Command Signal displays the actual command signal to the device in Volts. The Command Signal parameter is a monitor type. When working in one of the Inverse Modes, 2 and 4, the inverse of the command signal is displayed, e.g. 20 mA command is displayed as 0 mA.

**OUTPUT CURRENT** - Output Current displays the nominal current being supplied to the output. The Output Current parameter is a monitor type.

**SUPPLY VOLTAGE** - The Supply Voltage parameter displays the module's power supply voltage. This value is included as an aid to troubleshooting. The Supply Voltage parameter is a monitor type.

**FAULT STATUS** - The Fault Status parameter displays the current fault code when a fault exists as shown in the table below. The Fault Status parameter is a monitor type. In addition to the on-screen fault status, the STATUS light will flash red indicating a problem. The light will flash a number of times periodically corresponding to the fault codes below.

Code	Fault	RED LED Flashes
1	Over Current	☹
2	Open Output	☹☹
3	Output Shorted	☹☹☹

**Configuration**

All of the amplifier set up operations are accomplished with the use of 4 buttons. These buttons are Lock, Unlock, Up, and Down. The Programmer represents these in graphical form as padlocks and arrows.

Both the PC-based set up software and the Hand Held Programmer have a two-line display. The up and down arrows are used to navigate through the parameter list. When either button is pressed, the display will be updated with the next parameter in the list. The parameter name will appear on the first line and the associated setting will appear on the second line. The list is accessed in a circular fashion, stepping down from the last parameter to the first and vice-versa.

To change the setting of a variable parameter, the user must press the unlock button to place the system in edit mode. While in edit mode, the display will show the Up and Down arrows together at the beginning of the second line. In edit mode, the up and down buttons are used to change the value of the parameter. For parameters which contain both variable and monitor data, the monitor data is shown surrounded by square brackets. Once the desired setting is displayed, pressing the lock button will save the parameter and end the edit mode.

**Ordering Information**

The following is a breakdown of the 790-2\*\*\*A part numbering system:

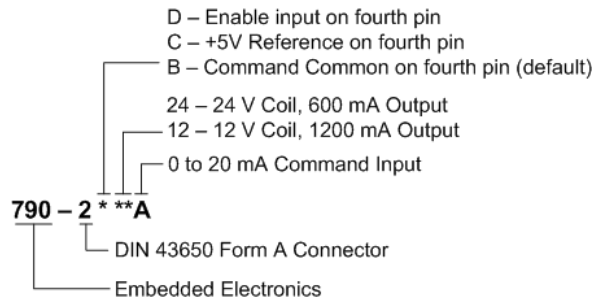

**Wiring**

Wiring functions are listed in the table below. Following the table are wiring examples for various modes of operation.

**Notes:**

- To establish the infrared communications link, it is essential that the infrared communication windows remain free from any obstruction such as paint or other material.
- For acceptable EMC immunity, a shielded cable should be used. Shield drain should be attached to earth ground.
- For complete overload protection, a fuse should be installed as shown in the circuit diagram.

Terminal	Function
1	Supply Common
2	+V Supply
3	Command Input
4	Option B- Command Common

Note: A source type input is required. A sinking type analog input will damage the amplifier.

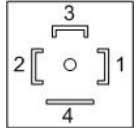

**Single Solenoid Joystick Control, Option B-Command Common**

The Amplifier can be controlled with a joystick or potentiometer as shown. This configuration uses Mode 3 with the Enable signal or Mode 1 with no Enable line.

N/A

**Single Solenoid PLC Control, Option B- Command Common**

The Amplifier can be controlled with PLC as shown. This configuration uses Mode 1 with no Enable line.

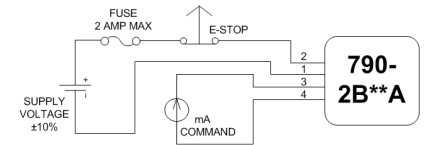

**Single Solenoid 2-Speed Control, Option B- Command Common**

The Amplifier can be configured for 2-speed mode as shown. In this arrangement the Enable signal allows minimum output and the Command signal allows maximum output. This configuration corresponds to Mode 5.

N/A

**Single Solenoid 2-Speed Control, Option B- Command Common**

The Amplifier can be configured for 2-speed mode as shown. In this arrangement the Enable signal allows maximum output and the Command signal limits output to the minimum setting. This configuration corresponds to Mode 6.

N/A

**Wiring**

Wiring functions are listed in the table below. Following the table are wiring examples for various modes of operation.

**Notes:**

- To establish the infrared communications link, it is essential that the infrared communication windows remain free from any obstruction such as paint or other material.
- For acceptable EMC immunity, a shielded cable should be used. Shield drain should be attached to earth ground.
- For complete overload protection, a fuse should be installed as shown in the circuit diagram.

Note: A source type input is required. A sinking type analog input will damage the amplifier.

Terminal	Function
1	Supply Common
2	+V Supply
3	Command Input
4	Option C- +5V Reference

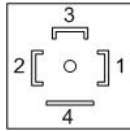

**Single Solenoid Joystick Control, Option C- +5V Reference**

The Amplifier can be controlled with a joystick or potentiometer as shown. This configuration uses Mode 3 with the Enable signal or Mode 1 with no Enable line.

N/A

**Single Solenoid PLC Control, Option C- +5V Reference**

The Amplifier can be controlled with PLC as shown. This configuration uses Mode 3 with the Enable signal or Mode 1 with no Enable line.

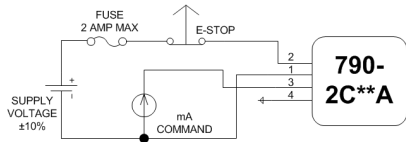

**Single Solenoid 2-Speed Control, Option C- +5V Reference**

The Amplifier can be configured for 2-speed mode as shown. In this arrangement the Enable signal allows minimum output and the Command signal allows maximum output. This configuration corresponds to Mode 5.

N/A

**Single Solenoid 2-Speed Control, Option C- +5V Reference**

The Amplifier can be configured for 2-speed mode as shown. In this arrangement the Enable signal allows maximum output and the Command signal limits output to the minimum setting. This configuration corresponds to Mode 6.

N/A

**Wiring**

Wiring functions are listed in the table below. Following the table are wiring examples for various modes of operation.

**Notes:**

- To establish the infrared communications link, it is essential that the infrared communication windows remain free from any obstruction such as paint or other material.
- For acceptable EMC immunity, a shielded cable should be used. Shield drain should be attached to earth ground.
- For complete overload protection, a fuse should be installed as shown in the circuit diagram.

Note: A source type input is required. A sinking type analog input will damage the amplifier.

Terminal	Function
1	Supply Common
2	+V Supply
3	Command Input
4	Option D- Enable Input

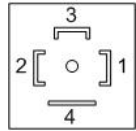

**Single Solenoid Joystick Control, Option D- Enable Input**

The Amplifier can be controlled with a joystick or potentiometer as shown. This configuration uses Mode 3 with the Enable signal or Mode 1 with no Enable line.

N/A

**Single Solenoid PLC Control, Option D- Enable Input**

The Amplifier can be controlled with PLC as shown. This configuration uses Mode 3 with the Enable signal or Mode 1 with no Enable line.

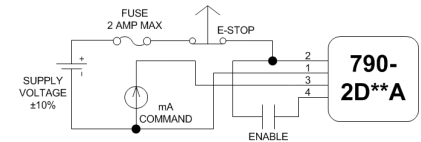

**Single Solenoid 2-Speed Control, Option D- Enable Input**

The Amplifier can be configured for 2-speed mode as shown. In this arrangement the Enable signal allows minimum output and the Command signal allows maximum output. This configuration corresponds to Mode 5.

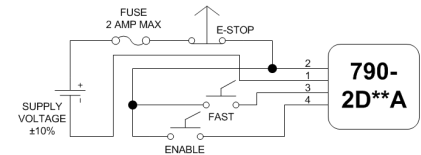

**Single Solenoid 2-Speed Control, Option D- Enable Input**

The Amplifier can be configured for 2-speed mode as shown. In this arrangement the Enable signal allows maximum output and the Command signal limits output to the minimum setting. This configuration corresponds to Mode 6.

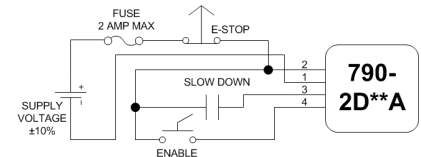

**Setup Procedure**

**Note: Changing parameter settings may cause sudden and unexpected machine movements. Care must be taken to prevent injury, death, or damage of equipment.**

1. Install the infrared Cable Adapter to the Embedded Amplifier paying particular attention to the orientation of the Adapter—the logo side should face away from the coil and towards the embedded amplifier. The connector end must connect to either a PC (with set up software loaded) or the HHP.
2. Power must be applied to the Embedded Amplifier. When using the HHP, turn on the HHP by briefly pressing the yellow power button marked with the international power symbol I/O. The title screen for the HHP should appear. When using the PC-based set up software, load the program.
3. Parameter definition should be set in the descending order as shown in the parameter table above to avoid a common mistake.
4. Pressing the green Unlock button when a variable parameter is displayed puts the amplifier into the edit mode.
5. With the MODE parameter displayed on the LCD screen, the correct mode setting is selected by pressing the green Unlock button to enter the edit mode. Use the Up or Down arrows to scroll through the list of six modes. Not all modes of operation will be available and will depend on the fourth pin option selected. The mode is determined by the intended use and the typical wiring diagrams shown on the previous page. Once the correct mode has been selected, press the red Lock button to commit the change to memory and exit the edit mode.
6. Press the Down arrow to display the MINIMUM INPUT parameter. The first number shown on the second line is the setting value that is a variable. The second number, shown in square brackets, is the monitored value currently present. Pressing the Unlock button enters the edit mode. The minimum input setting can be changed by pressing the Up arrow to increase the value or the Down arrow to decrease the setting. The value selected is determined by the minimum command value that is achievable recognizing that selecting a value lower than is actually achievable will not allow for the optimum linearity and selecting a value too high reduces the control resolution. Selecting a value too low could also make the amplifier susceptible to electro-magnetic interference (EMI). The smallest value that may be selected is 0 mA. Once the value has been selected, pressing the red Lock button commits the change to memory and exits the edit mode. When working in the Inverse Mode, the monitored value displayed is the inverse value, e.g. 20 mA command is displayed as 0 mA.
7. Press the Down arrow to display the MAXIMUM INPUT parameter. Again the first number shown on the second line is the setting value and it is variable. The second number, shown in square brackets, is the monitored value currently present. Pressing the Unlock button allows the value to be edited either by increasing as the Up arrow is pressed or decreased as the Down arrow is pressed. The value selected is determined by the maximum command value that is achievable recognizing that selecting a value that is too high will not allow for the optimum linearity and selecting a value that is too low reduces the control resolution. The maximum value that may be selected is 20 mA. Once the value has been selected, pressing the red Lock button commits the change to memory and exits the edit mode. When working in the Inverse Mode, the monitored value displayed is the inverse value, e.g. 20 mA command is displayed as 0 mA.
8. Press the Down arrow to display the MINIMUM OUTPUT parameter. This parameter is sometimes called dead band compensation. The first number shown on the second line of the display is the setting value while the number in square brackets is the monitored value currently present. Pressing the green Unlock button enters the edit mode to allow for the setting to be changed. Press the Up arrow to increase the value or press the Down arrow to decrease the value. The value specified is determined by what value of current is needed when the MINIMUM INPUT value has been reached. A low value will increase the control resolution while a higher value will compensate for the difference for the current value between the valve components not moving and moving. Once the value has been selected, pressing the red Lock button commits the change to memory and exits the edit mode.
9. Press the Down arrow to display the MAXIMUM OUTPUT parameter. Again the first number shown on the second line is the setting value while the number in square brackets is the monitored value currently present. Pressing the green Unlock button enters the edit mode to allow for the setting to be changed. Press the Up arrow to increase the value or press the Down arrow to decrease the value. The value selected is determined by the pressure or flow required at maximum power to the solenoid coil. However, the maximum current value should not exceed the recommended value for the coil being used. Exceeding the recommended value will dramatically shorten the life of the coil by producing excess heat. Presently, the recommended maximum current value for a Sun coil produced after January 2005 (black dichromate coil can) is 590 mA for a 24 Volt coil and 1150 mA for a 12 Volt coil. Selecting a value too low will limit the performance of the valve. Once the value has been selected, pressing the red Lock button commits the change to memory and exits the edit mode.



10. Press the Down arrow to display the DITHER FREQ. parameter. The number shown on the second line is the dither frequency in Hertz. Presently, the recommended dither frequency for Sun valves is 140 Hz. Dither is a small amplitude oscillation at the specified frequency used to reduce friction within the valve that allows for better performance. The lower the frequency, the larger the amplitude of oscillation and vice versa, the larger the frequency, the smaller the amplitude of oscillation. The amplitude is not user definable and cannot be set independently. Once the value has been selected, pressing the red Lock button commits the change to memory and exits the edit mode.
11. The RAMP UP and RAMP DOWN parameters are ramp rates determined by the rate input as described in steps 12 and 13 below. The equation below describes the relationship between actual ramp time in seconds and the RAMP UP/DOWN parameter in seconds.

$$RampTime[s] = (CommandStep[mA]) \left( \frac{100 \text{ s RampParameter}}{FullCommand[20mA]} \right) = 100 \text{ s}$$

12. Press the Down arrow to display the RAMP UP parameter. The number shown on the second line is the ramp time in seconds. A value between 0 and 120 seconds may be selected. Once an increase in command is detected, the Amplifier will increase power to the coil in a linear manner over the ramp rate selected. Once the value has been selected, pressing the red Lock button commits the change to memory and exits the edit mode.
13. Press the Down arrow to display the RAMP DOWN parameter. The number shown on the second line is the ramp time in seconds. A value between 0 and 120 seconds may be selected. Once a decrease in command is detected, the Amplifier will decrease power to the coil in a linear manner over the ramp rate selected. The RAMP UP and RAMP DOWN parameters are not required to be the same. Once the value has been selected, pressing the red Lock button commits the change to memory and exits the edit mode.
14. Setup of the Embedded Amplifier is complete. Continuing to press the Down arrow allows viewing of the monitored parameters supply voltage, output current, and fault status. The monitored parameters are useful in troubleshooting.