



# Sun FLeX Series Solenoid Valves

## HIGH RELIABILITY

*Designed & tested to 10-million operational cycles at full rated pressure*

## ZINC-NICKEL COATING STANDARD

*Offers 1,000-hour salt fog protection*

## USES 740 & 747 SERIES DC COILS

*High-power & hazardous location coils*

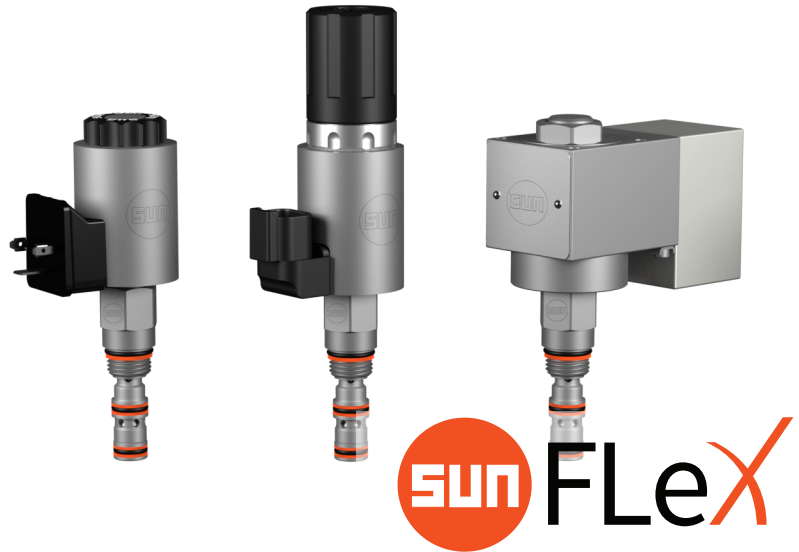

# DWBF

5000 psi (350 bar)  
T-150A cavity

3-WAY, DIRECT-ACTING,  
SOLENOID-OPERATED DIRECTIONAL  
BLOCKING POPPET VALVE

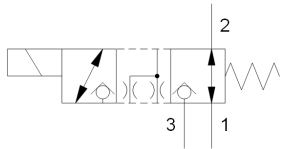

DWBF-\*A\*  
5000 psi (350 bar)

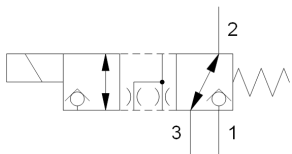

DWBF-XN\*  
5000 psi (350 bar)

## TABLE OF CONTENTS

Technical Features	2
Model Configurations & Options	3
Technical Specifications	4
Performance Curves	5
Dimensional Drawings	6
Cavity Drawing & Tooling	7
Accessories	8

[sunhydraulics.com/model/DWBF](http://sunhydraulics.com/model/DWBF)

## DWBF 3-WAY, DIRECT-ACTING, SOLENOID-OPERATED DIRECTIONAL BLOCKING POPPET VALVE

SERIES 0, CAVITY: T-150A

The 3-way, two position directional poppet valves are direct acting and feature a pressure-balanced design. They are comprised of a coil nut (1), a solenoid with coil (2), a hex body (3), a spring (4), a poppet (5), and two valve seats (6, 7).

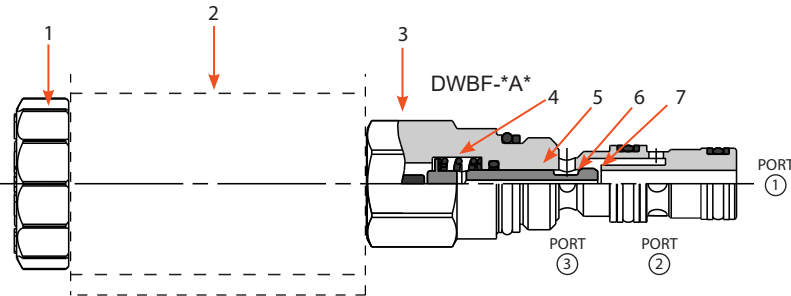

### DWBF-\*A\* (Normally Open 2 to 1, Closed 3 to 2)

**Function:** When de-energized, the poppet(5) is pulled against the valve seat (6) by the spring (4), closing the valve in the 3 to 2 flow path and allowing bidirectional flow in the 2 to 1 flow path. When energized, the solenoid with coil (2) pushes the poppet (5) off the seat (6) onto the other seat (7), allowing bidirectional flow in the 3 to 2 flow path and blocking flow in the 2 to 1 flow path.

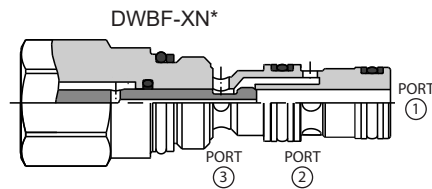

### DWBF-\*XN\* (Normally Open 3 to 2, Closed 2 to 1)

**Function:** When de-energized, the poppet (5) is pushed against the valve seat (7) by the spring (4), closing the valve in the 2 to 1 flow path and allowing bidirectional flow in the 3 to 2 flow path. When energized, the solenoid with coil (2) pushes the poppet (5) off the seat (7) onto the other seat (6), allowing bidirectional flow in the 2 to 1 flow path and closing the valve in the 3 to 2 flow path.

## TECHNICAL FEATURES

- All FLeX Series valves incorporate the Sun floating-style construction to minimize the possibility of internal parts binding due to excessive installation torque and/or cavity/cartridge machining variations.
- Designed and tested to 10-million operational cycles at full rated pressure
- Exceeds the new NFPA test standard T2.6.1 R2014 for fatigue and burst pressure ratings.
- Higher flow rates than competing valves of similar size.
- Extremely low leakage – 0.004 in<sup>3</sup> (0,07 cc)/min (1 drop/min)
- Designed using CFD simulation for optimized geometries.
- Zinc-nickel plating standard for 1000-hour salt fog protection.
- Direct actuated and requires no minimum hydraulic pressure for operation.
- Manual push-version override options are available in the "A" poppet configurations (DWBF-\*A\*). The force on the "M" manual override must not exceed 25 lbf (110 N).
- Suitable for load-holding applications when using the normally closed option. See the website for more information.
- A wide variety of coil termination and voltage options are available, with and without surge protection. See the CONFIGURATION section.
- Can be used with high-power (25-W) and hazardous location coils.
- Coil connector options offer ratings up to IP69K. See individual coil product pages for details.
- Port 3 is the preferred inlet for this valve. Port 1 is limited to half capacity.

## MODEL CODE EXPLANATION

Sun cartridges have a base seven-digit part number. Each of the digits in the sequence has significance as shown in the model code explanation below. Available options and

modifiers for specific cartridges, manifolds, and valve packages are shown on the individual product pages and data sheets. Not all modifiers are applicable for every model.

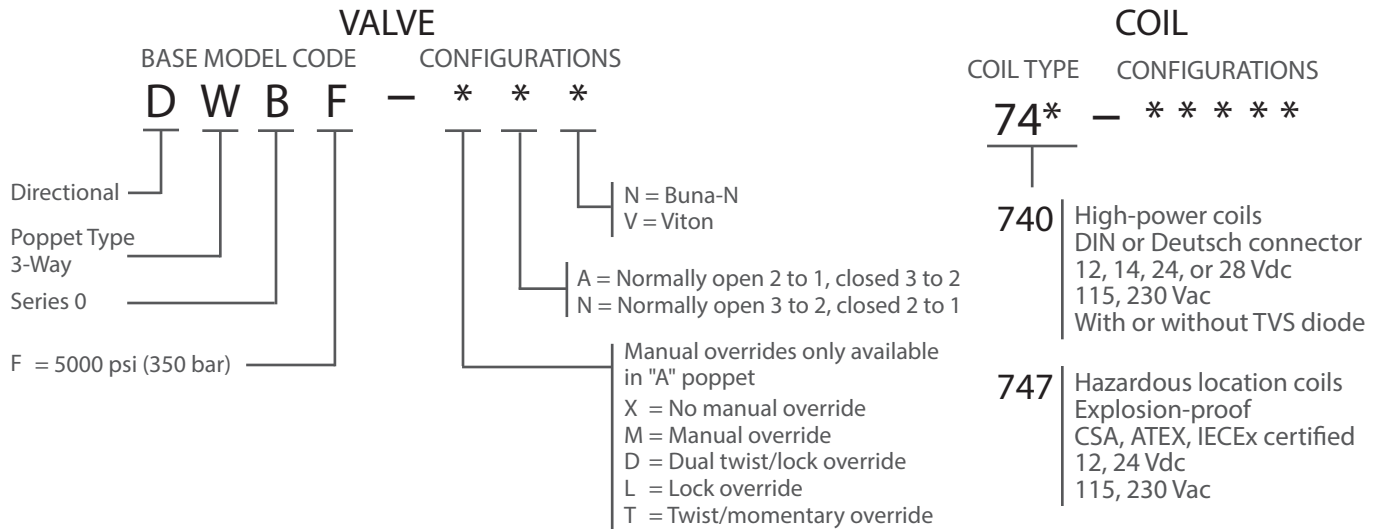

### Important Note:

When performing model code searches on [www.sunhydraulics.com](http://www.sunhydraulics.com), do not include setting(s). When ordering, no spaces or dashes are used.

See individual coil data sheets for full coil configuration.

## COMPATIBLE COILS

The DWBF 5000-psi (350-bar) valves use only the high-power 740 Series (25-W) coils and the hazardous location coils.

### High-Power (25-W) Coils

Voltage	DIN 43650 Form A (IP65/IP67)	Deutsch DT04-2P (IP69K)	Resistance @20°C (ohms) ±10% (with diode*)	TVS Diode (Nominal) Breakdown Voltage (with diode*)
12 Vdc	<a href="#">740-212</a>	<a href="#">740-912</a>	5.8 Ω	68 Vdc
14 Vdc	<a href="#">740-214</a>	<a href="#">740-914</a>	7.8 Ω	68 Vdc
24 Vdc	<a href="#">740-224</a>	<a href="#">740-924</a>	23.0 Ω	68 Vdc
28 Vdc	<a href="#">740-228</a>	<a href="#">740-928</a>	31.4 Ω	68 Vdc
115 Vac	<a href="#">740-211</a>	N/A	416 Ω	250 Vac
230 Vac	<a href="#">740-223</a>	N/A	1686 Ω	400 Vac

\* Above model codes are shown without transient voltage suppression (TVS) diodes. To order 740 Series coils with a TVS diode, append model code with "D" (Example: 740-212LD).

### Hazardous Location, Explosion-Proof (30-W) Coils

Voltage	M20 x 1.5 180°	M20 x 1.5 90°	1/2" NPT 180°	1/2" NPT 90°	Wattage @ 20°C	Circuitry
12 Vdc	<a href="#">747-JM12BD</a>	<a href="#">747-JM12CD</a>	<a href="#">747-JN12BD</a>	<a href="#">747-JN12CD</a>	29.6 W	With diode
24 Vdc	<a href="#">747-JM24BD</a>	<a href="#">747-JM24CD</a>	<a href="#">747-JN24BD</a>	<a href="#">747-JN24CD</a>	29.9 W	With diode
115 Vac	<a href="#">747-JM11BD</a>	<a href="#">747-JM11CD</a>	<a href="#">747-JN11BD</a>	<a href="#">747-JN11CD</a>	29.7 W	Rectified
230 Vac	<a href="#">747-JM23BD</a>	<a href="#">747-JM23CD</a>	<a href="#">747-JN23BD</a>	<a href="#">747-JN23CD</a>	28.9 W	Rectified

**DWBF** 3-WAY, DIRECT-ACTING, SOLENOID-OPERATED  
DIRECTIONAL BLOCKING POPPET VALVE

TECHNICAL SPECIFICATIONS	DWBF
Maximum Operating Pressure	5000 psi (350 bar)
Maximum Flow Rate	6.0 gpm (22,7 L/min)
Nominal Flow Rate	3.3 gpm (12,5 L/min) A poppet* 2.2 gpm (8,3 L/min) N poppet*
Sun Cavity	T-150A
Sun Cartridge Series	Series 0
Response Time - Typical	50 ms (open & close)
Typical Internal Leakage at 110 SYS (24 cSt) (at maximum operating pressure)	0.004 in <sup>3</sup> (0,07 cc)/min (1 drop/min)
Switching Frequency - Maximum	3 Hz (10,000 cycles/hour)
Viscosity Range	2,8 to 380 cSt or 35 to 2000 SUS
Filtration	Minimum cleanliness (ISO 4406 1999, 4/6/14 µm) 19/17/14
Valve Hex Size	0.75 in (19,1 mm)
Valve Installation Torque	25 - 30 lbf ft (35 - 40 N-m)
Mounting Position	No restrictions
Valve Weight (excluding coil)	1.25 lbs (567 g)
Seal Kit - Viton	990-150-006
Seal Kit - Buna	990-150-007
Seal and nut kit - Coil	990-740-006

\*See performance curves on page 5 for more details.

## TYPICAL PRESSURE DIFFERENTIAL VS. FLOW

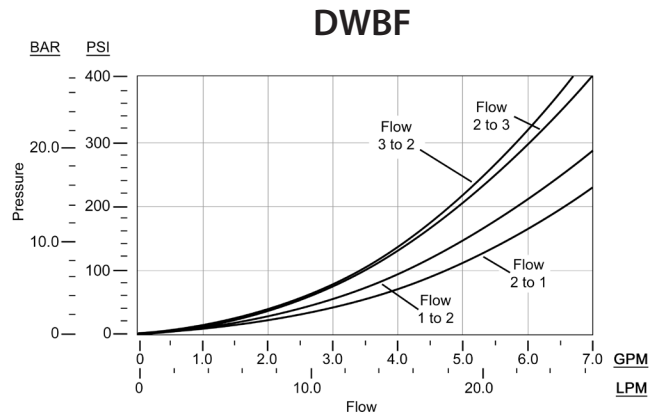

## PERFORMANCE LIMITS @ MAXIMUM AMBIENT TEMPERATURE AND 15% UNDERVOLTAGE WITH HP COIL

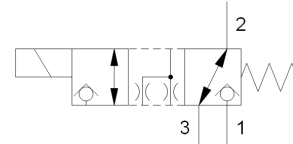
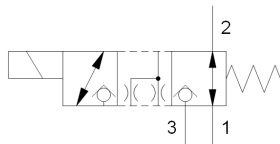

### DWBF-XA\*

### DWBF-XN\*

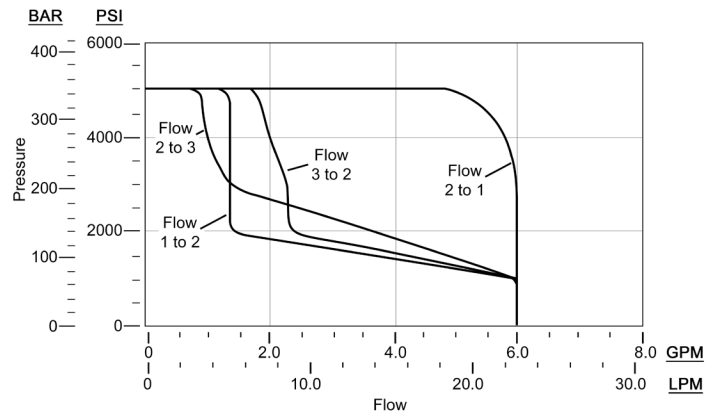
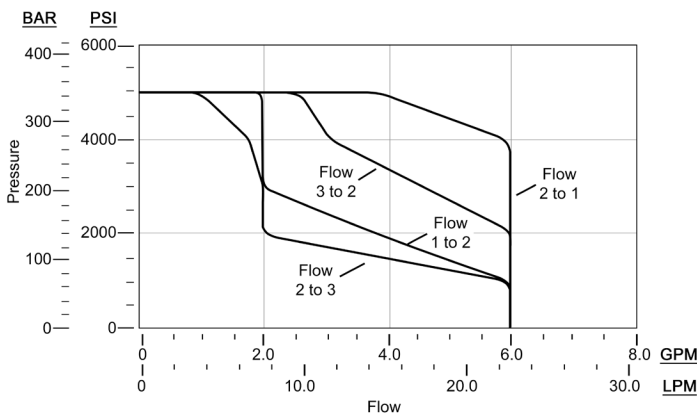

### Testing: Worst-Case Conditions

Sun Hydraulics bases solenoid valve performance data on testing at maximum ambient temperature (50° C) and 15% undervoltage at stabilized current (580 mA). This ensures that our data represents valve performance under worst-case conditions.

For additional information on Sun's valve testing standards, please refer to our website:  
<https://www.sunhydraulics.com/tech-resources/performance-data>.

## DWBF WITH 740 SERIES HIGH-POWER COILS

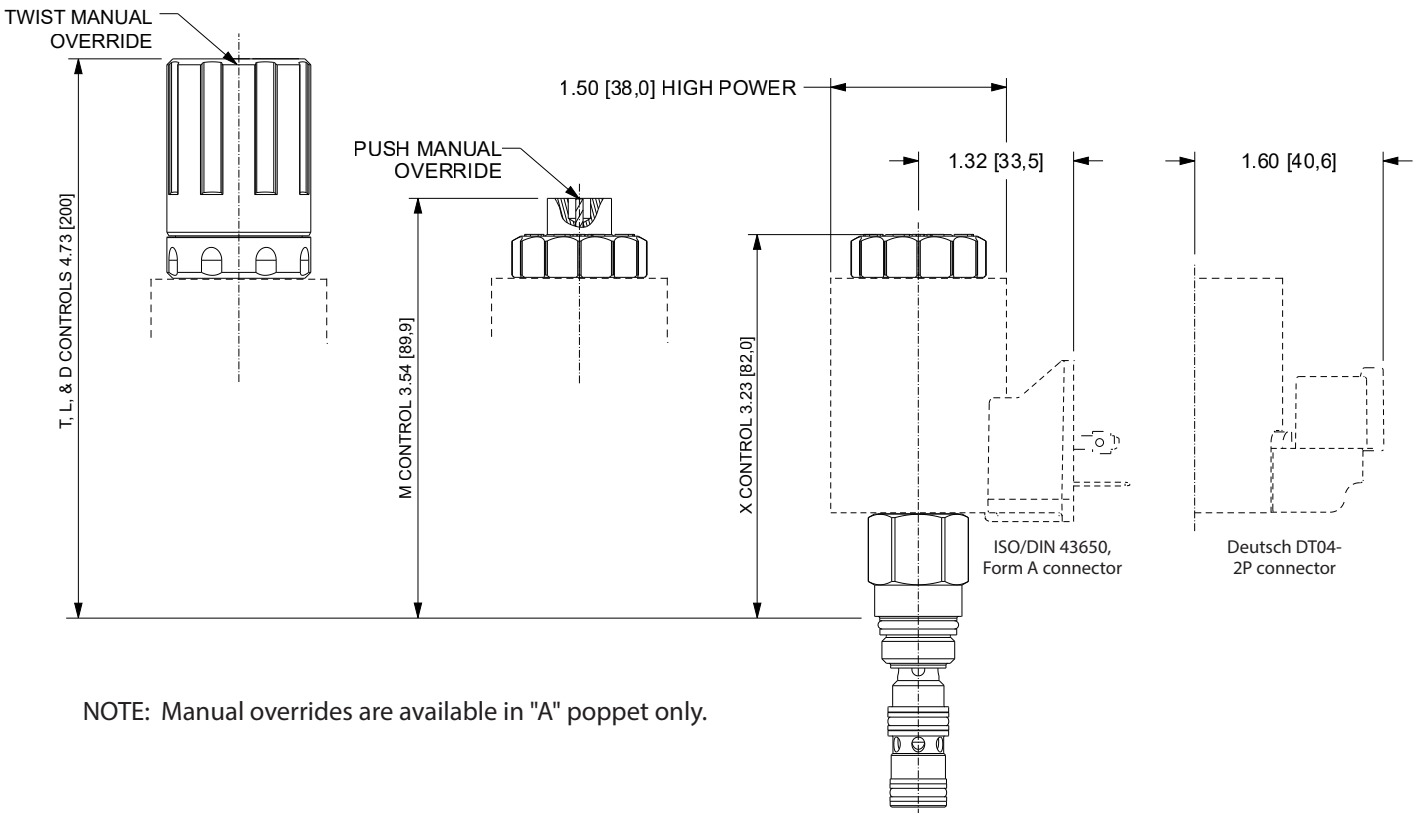

NOTE: Manual overrides are available in "A" poppet only.

## 747 SERIES HAZARDOUS LOCATION COILS

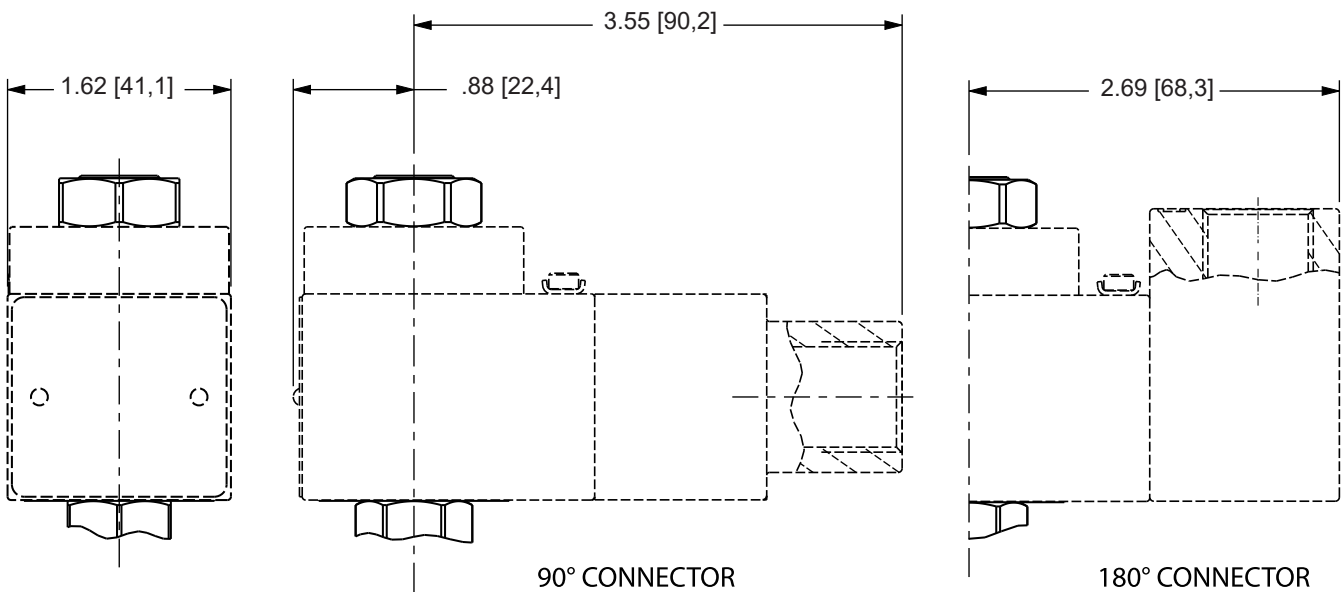

NOTE: Please verify cartridge clearance requirements when choosing a Sun manifold. Different valve controls and coils require different clearances. An additional minimum 2.0 in. (50,8 mm) beyond the valve extension is needed for coil installation and removal.

T-150A CAVITY DIMENSIONAL DRAWING

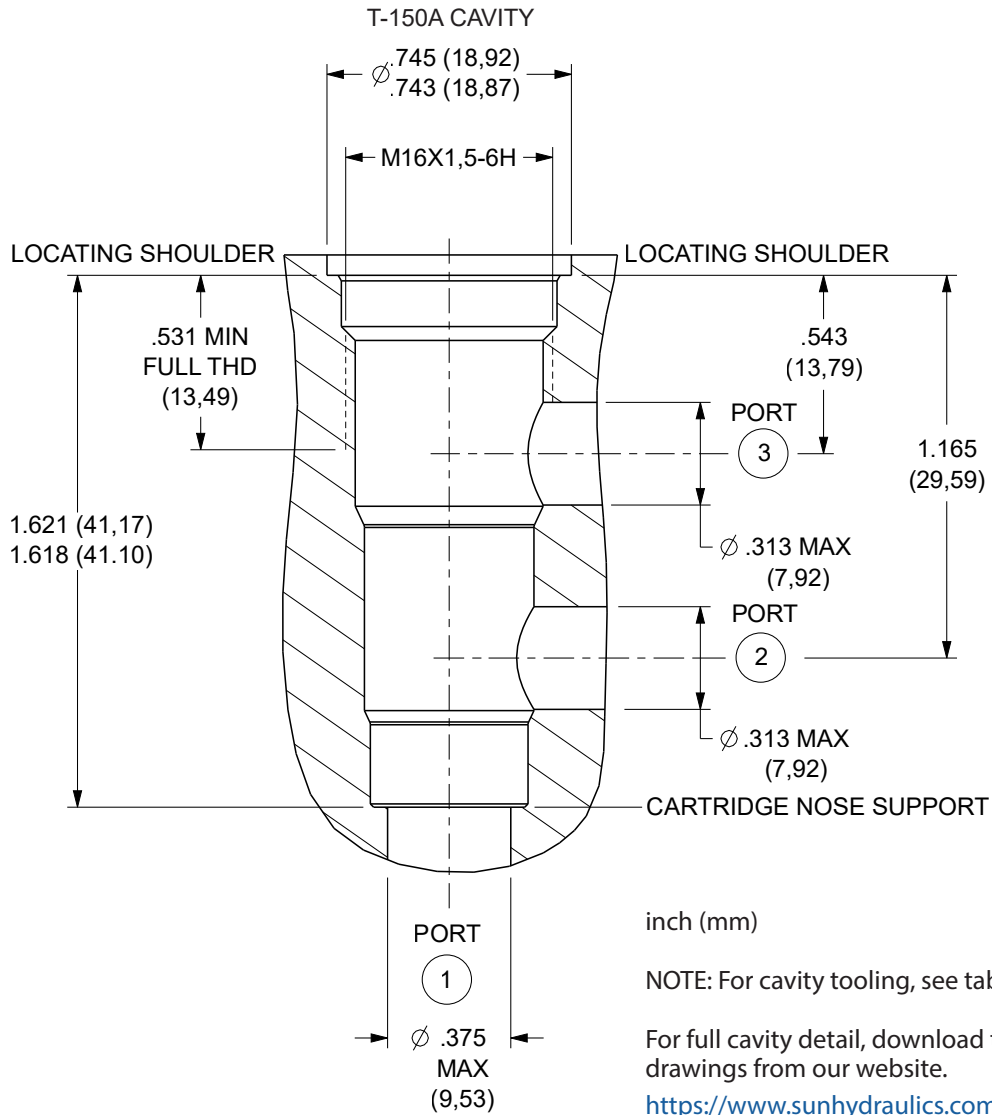

T-150A CAVITY TOOLING

DESCRIPTION	HIGH-SPEED STEEL	TITANIUM COATED
M20 X 1.5-6H tap, straight shank	998991	998991101
Series 1 deep hex socket	998100005	
T-150A cavity form drill, morse taper	994150001	994150101
T-150A cavity form drill, straight shank	994150002	994150102
T-150A cavity form reamer, morse taper	995150001	995150101
T-150A cavity form reamer, straight shank	995150002	995150102

## ACCESSORIES

### XMD Single- and Dual-Output Drivers

The XMD is a single- or dual-output driver used with solenoid-operated valves for the mobile and industrial hydraulic industries. The driver can be mounted on a manifold using the standard mount clip or directly to the low- and high-power coils using an optional coil-mount clip.

DESCRIPTION	PART NUMBER
Single-output PWM driver with standard mounting bracket	XMD-01
Dual-output PWM driver with standard mounting bracket	XMD-02



### Wire Harnesses

DESCRIPTION	PART NUMBER
Wire harness, 2-pin Deutsch-to-Metri-Pack Conversion	991-717
Wire harness, 2-pin Deutsch-to-Amp Jr Timer Conversion	991-718
Wire harness, 2-pin Deutsch-to-Twin-Lead Conversion	991-719

NOTE: Use proper wiring harnesses to maintain IP69K seal ratings on the Deutsch connectors.

## STANDARD LINE-MOUNT MANIFOLDS

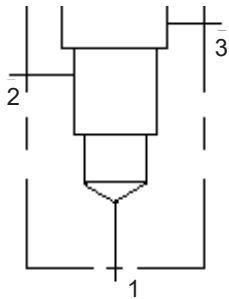

The DWBF family of FLeX valves is based on the new Sun T-150A cavity. Currently, there are nine standard single-cavity, 90-degree line mount manifolds available in a wide range of port sizes for the new T-150A cavity. More standard manifolds will be introduced soon, including two-cavity and sandwich style manifolds for this new cavity.

Visit our website to see a complete list of available [standard manifolds for the T-150A cavity](#).



Sun Hydraulics Headquarters  
Sarasota, Florida USA  
+1 941 362 1200

Custom Fluidpower Pty Ltd  
(A Sun Hydraulics Company)  
Newcastle, Australia  
+61 02 4953 5777  
[sales@custom.com.au](mailto:sales@custom.com.au)

Sun Hydraulics Limited  
Coventry, England  
+44 2476 217 400  
[sales@sunuk.com](mailto:sales@sunuk.com)

Sun Hydraulics Korea Corp.  
Incheon, Korea  
+82 3281 31350  
[sales@sunhydraulics.co.kr](mailto:sales@sunhydraulics.co.kr)

Sun Hydraulik GmbH  
Erkelenz, Germany  
+49 2431 80910  
[sales@sunhydraulik.de](mailto:sales@sunhydraulik.de)

Sun Hydraulics China Co. Ltd.  
Shanghai, P.R. China  
+86 2162 375885  
[sunchinainfo@sunhydraulics.com](mailto:sunchinainfo@sunhydraulics.com)

Sun Hydraulics Corp. (India)  
Bangalore, India  
+91 8028 456325  
[sunindiainfo@sunhydraulics.com](mailto:sunindiainfo@sunhydraulics.com)

Sun Hydraulics Corp. (S.America)  
Rosario, Argentina  
+54 9 341 584 3075  
[ventas@sunhydraulics.com](mailto:ventas@sunhydraulics.com)